

Get the Most Out of Your Resources

Technology for Processing Your Biomass

For biogas, thermal use, compost

- ▶ Hammer mills & shredders
- ▶ Depackaging machines
- ▶ Screw presses
- ▶ Plant design & engineering



This is Tietjen

We have been developing, designing, and producing hammer mills and grinding technology in Germany since 1959.

Since 2007, this has also included the processing and separation of substrates for biogas production.

Complex customer requirements are our specialty: from the first contact to the delivery of the optimum system and after-sales service, we are your competent partner for the processing of your biomass.

We ensure that your resources are optimally used – worldwide.



Processing Technology for Your Biomass

Food or biowaste, solid manure, silage, wood waste or crop residues – these biomasses are valuable resources for energy production. They are processed by our machines to achieve e.g. the highest biogas yield.

We know that every customer has individual requirements and needs. That's why our employees first try to understand our customers. Together, we define the process for preparing the substrates.

Especially when processing waste, manure or wood waste, the machines are exposed to heavy loads such as impurities. This requires robust, durable, and reliable machines that can withstand these challenging demands. This is what Tietjen stands for.

Various substrate processing tasks are performed on our machines:

- ▶ Separating and processing municipal and commercial biowaste
- ▶ Shredding and grinding of manure, silage, bagasse, straw, unpackaged food waste, harvest, and slaughterhouse waste
- ▶ Preparation of substrates for plant cultivation and/or as a peat substitute
- ▶ Shredding and grinding of wood, straw, and other fibrous materials
- ▶ Optimization of the substrate before and next to the fermenter



Substrate Processing for Biomass

Biomass from Municipal and Commercial Biowaste

Depackaging Machine DRM



- ▶ Separating organics and inorganics from packaged or mixed food and biowaste

Screw Press PRS



- ▶ Dewatering of packaging residues after unpacking, general dewatering of structured materials

Hammer Mill BIMIX



- ▶ Wet grinding of unpackaged food waste, agricultural waste and slaughterhouse waste

Find Our Brochures and Data Sheets Online

Technical data, more detailed images and unique selling points can be found in our data sheets.

tietjen-original.com/en/downloads



Agricultural Waste

Biomass Shredder BMS



- ▶ Shredding of manure, silage, straw, crops and agricultural waste for biogas production

Hammer Mill IMPRA



- ▶ Installation in biogas plants next to the fermenter, finer processing of substrate components that are difficult to ferment to increase the biogas yield

Application Overview

Legend:

- Recommended solution
- Possible solution

	DRM	PRS	BIMIX	BMS	IMPRA
Applications					
Biogas	●	●	●	●	●
Thermal utilization				●	
Soil management/peat replacement/compost				●	
Special applications**	●	●	●	●	●
Materials					
Manure, silage, bagasse, agricultural waste				●	●
Crops such as sugar beet and corn			●	●	●
Dry fibrous materials such as straw*				●	
Municipal & commercial biowaste	●	●	●		
Wood*				●	
By-products from food production*				●	
Further materials**	●	●	●	●	●
Process					
Shredding and grinding				●	●
Shredding and grinding with the addition of liquid			●		
Separating and processing	●	●			
Dewatering		●			
Installation biogas					
Before the fermenter	●	●	●	●	
Between fermenter and secondary fermenter					●

* Hammer mills for wood, by-product and fiber processing can also be found in our size reduction technology brochure.

** Your application/material is not listed, please contact us.





Treatment of Packaged or Mixed Organic Waste

Durable, proven and robust technology is what characterizes Tietjen's depackaging machine DRM, the screw press PRS and our plant engineering.

With Tietjen, you get a solution for processing your municipal and commercial biowaste as well as packaged and unpackaged food waste that precisely meets your requirements. From the individual depackaging machine DRM to a combination of DRM and the screw press PRS to complete waste processing plants with receiving hopper and washing system. We ensure that your substrate is of the highest purity, that your processes run smoothly and that you achieve the highest biogas yield with maximum economic efficiency. From our installations, the machines have proven to endure the toughest tests in the waste industry.



✓ Advantages

Depackaging Machine DRM

- ▶ Reliable separation of organics and inorganics
- ▶ High degree of purity of the organics after separation
- ▶ Double rotor principle enables:
 - a high dry matter content
 - reduces the addition of liquid
 - ensures precise separation
 - reduces organic losses
- ▶ Throughput up to 25 t/h
- ▶ Proven in 24/7 applications
- ▶ High tolerance to impurities

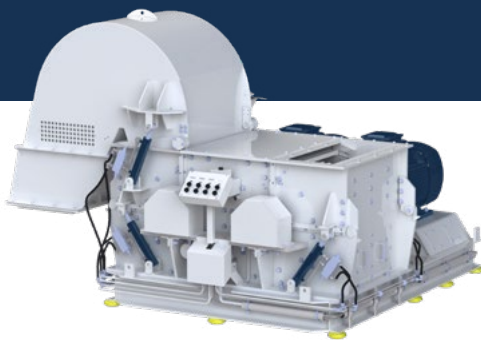

Screw Press PRS

- ▶ Reliable dewatering of inorganics
- ▶ Trouble-free operation: large inlet and outlet
- ▶ Pressure adjustment to different materials: automatic control of the press flaps
- ▶ Flushing nozzles for easy cleaning by backwashing
- ▶ Easy maintenance: quick-opening covers and segmented screens
- ▶ Reversible screw in the event of a malfunction fault



”

The best sustainability
criterion is still the long service
life of our machines.

Thomas Runde
Managing Director Tietjen

Waste Treatment Process Using the DRM

Our DRM works with the double rotor principle. Only in this way our de-packaging machine achieves above-average purity when processing mixed organics and food waste, as well as high throughput and process reliability.

Double rotor principle for gentle opening of packaging material with simultaneous sharp separation of foreign matter



Good to Know

How Purity Is Defined in the Depackaging Process

It is common to speak of 99 % or 99.5 % purity. It is important to know which basis is being referred to. If, for example, one assumes 5 kg of foreign matter in the waste stream of 1 t, this results in a purity level of 99.5 %. However, the reference to the dry mass is decisive for compliance with the guideline values. Assuming a dry matter content of 20 %, the waste stream minus water is reduced from 1 t to 200 kg.

However, the amount of foreign matter remains the same at 5 kg, resulting in a purity of 97.5 % based on the 200 kg of waste.

At Tietjen, we always refer to the dry mass when specifying purity. We have plants in countries with the most demanding requirements, are constantly improving our system and achieve the highest levels of purity.

Calculation example

1,000 kg waste,
5 kg foreign matter

= 99,5 % purity

200 kg waste (20 %
dry matter content),
5 kg foreign matter

= 97,5 % purity

Commercial Plants for Biowaste Treatment

Smooth separation of packaging and organics requires more than just a depackaging machine and a screw press.

The plant can only work efficiently and achieve a high level of organic purity with optimum acceptance, conveying and automatic control. The acceptance, emptying and cleaning of large waste contain-

ers is often part of a system. These process steps can be integrated into Tietjen's systems and can be carried out manually or fully automatically, depending on the customer's requirements.

Installation of depackaging machine DRM and screw press PRS



Typical Design of a Biowaste Treatment Plant

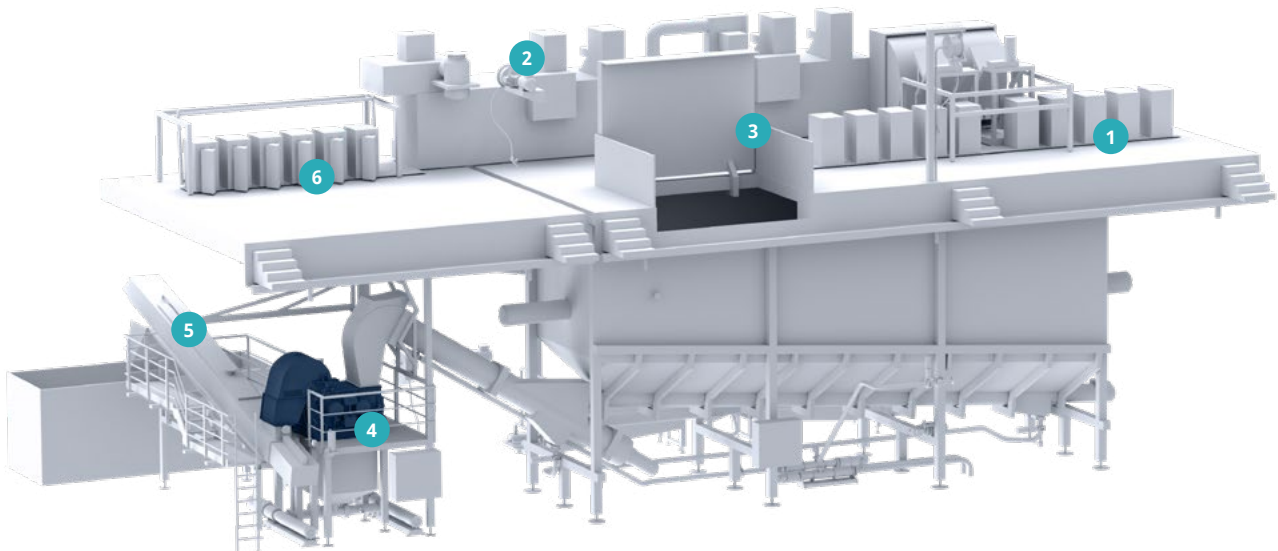

- 1 Acceptance and automatic discharge of containers or garbage cans
- 3 Truck acceptance of bulk material
- 5 Screw press for foreign matter
- 2 Containers/garbage cans washing system
- 4 Depackaging machine DRM
- 6 Output/storage area for clean waste garbage cans

Standardized and Individual Systems for Waste Processing

In plant construction for DRM, Tietjen offers standardized plant concepts and individually planned solutions.

Examples for standard configurations

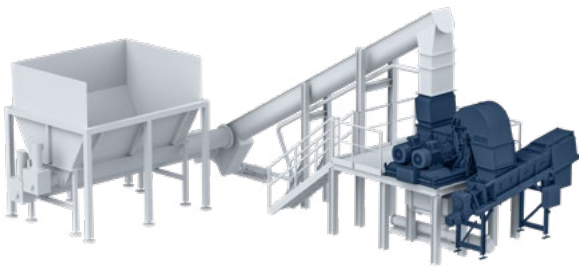

Small, compact system with above-ground receiving container, e.g. 15 – 40 m³, loading by forklift or wheel loader possible.

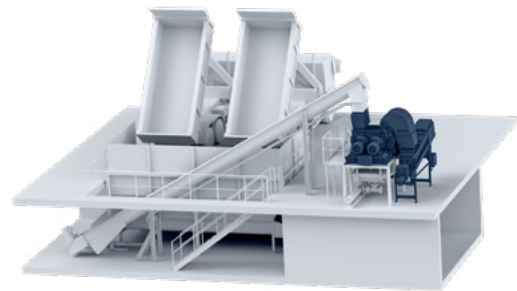

Compact system with 60 m³ receiving container in the floor, can be loaded by truck, forklift or via waste garbage cans.

Example for a large individual system

This plant consists of two lines, one for packaged or mixed food waste with the DRM and one for pure organic waste with the BIMIX, located in Spain.

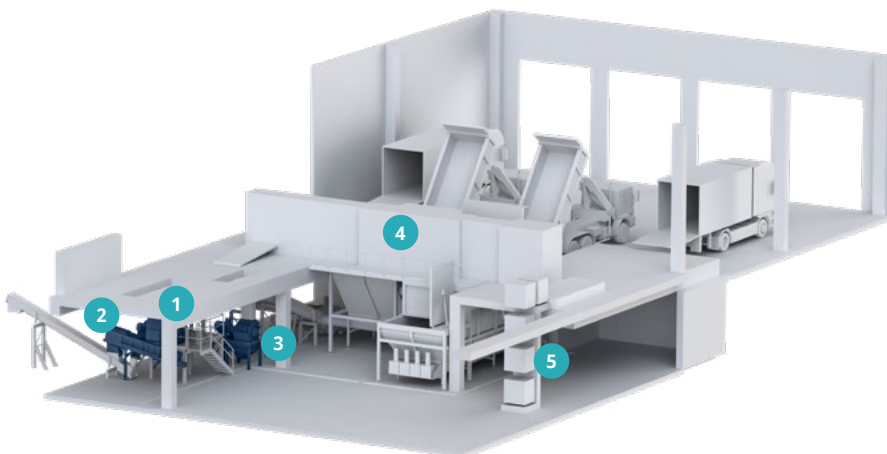

- 1 Depackaging machine DRM
- 2 Screw press PRS
- 3 Hammer mill BIMIX
- 4 Washing machine
- 5 Lift for containers

Efficient Grinding of Unpackaged Food, Harvest and Slaughterhouse Waste

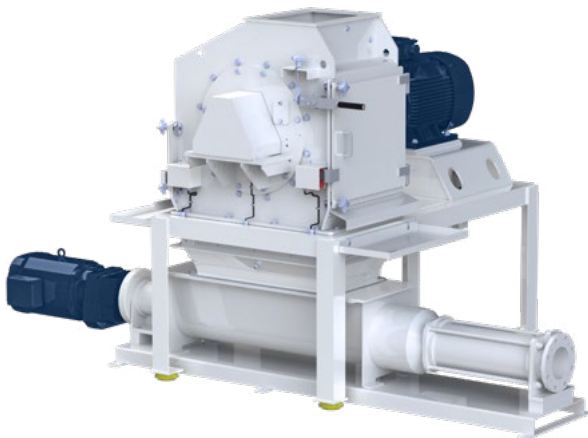

The robust hammer mill BIMIX with an extra-large inlet is suitable for the wet grinding of biomass into a pumpable product.

The BIMIX is used for grinding unpackaged organics and food waste. Thanks to its robust design, it can also process slaughterhouse waste with bone residues, for example. After grinding, a defined particle size is achieved, and the product is pumpable.

✓ Advantages

- ▶ Extremely robust – enables treatment of harsh material
- ▶ Large inlet – enables feeding of bulky, larger biomasses
- ▶ Adjustment of the particle size by changing the beater circumferential speed and the screen perforation
- ▶ Stainless steel – resists acids in food leftovers
- ▶ Optimized geometry – with larger impact area, single part screen and catch trap

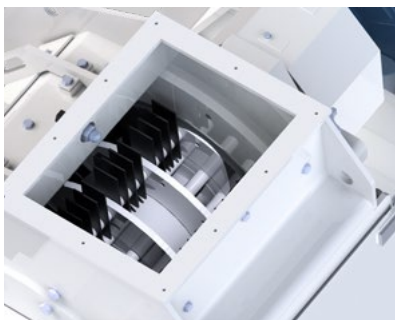

Large inlet



Optimized grinding chamber with screen and impact area



Door with foreign body catch trap

Efficient Grinding Technology for Biogas Plants



The biomass shredder BMS was developed from the outset specifically for shredding substrates for biogas production and perfectly meets the needs of biogas plant operators.

The biomass shredder BMS is a vertical shredder that processes more than 15 t/h biomass efficiently and homogeneously. The BMS optimally meets the requirements of biogas plant operators for high availability, low maintenance costs and high throughput.

Wear parts such as the beaters and rotor are made of wear-resistant material, can be used from both sides and are easy to change thanks to the large door opening.

The outlet in the base ensures reliable operation without blockages. The substrate is discharged either by a screw or a pump.

✔ Advantages

- ▶ Optimal preparation through defibering of the substrate
 - Increases the biogas yield
 - Prevents floating layers
 - Improves sand discharge
- ▶ Throughput from 8 t/h to >15 t/h, depending on model and motorization
- ▶ High availability and low maintenance costs
- ▶ Smooth process: no blockages or bridging

Solid Manure



Horse Manure

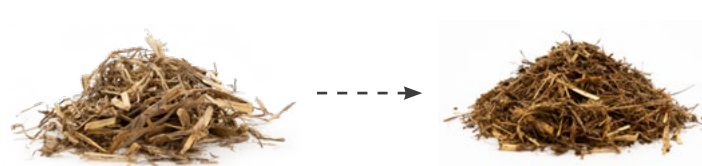

The BMS processes:

- ▶ Livestock manure from chickens, cattle, horses, turkeys or pigs
- ▶ Crop residues like corn and grass silage, grass cuttings and sugar beet
- ▶ Wood, straw, and other fibrous materials
- ▶ Agricultural residues as well as other types of biomasses

Optimally Adapted to the Dosing and Conveying Units

Well-coordinated interfaces and smooth processes are preconditions for a successful biogas production, which is why Tietjen developed the biomass shredder BMS together with a manufacturer of solid dosing units and experts from the biogas industry.

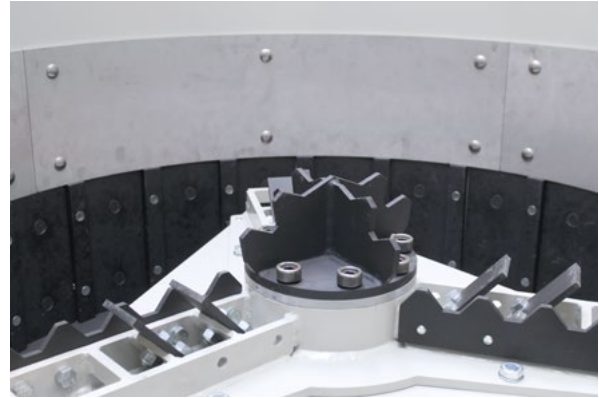

Typical Setup of the Biomass Shredder BMS Combined with a Dosing Unit

- 1 Dosing unit for loading by wheel loader, weight recording and automatic feeding of material into the BMS
- 2 Conveying unit to the biomass shredder BMS
- 3 Magnetic separator for sorting out metallic foreign matter
- 4 Biomass shredder BMS for grinding the biomass
- 5 Screw conveyor or pump to the fermenter
- 6 Fermenter

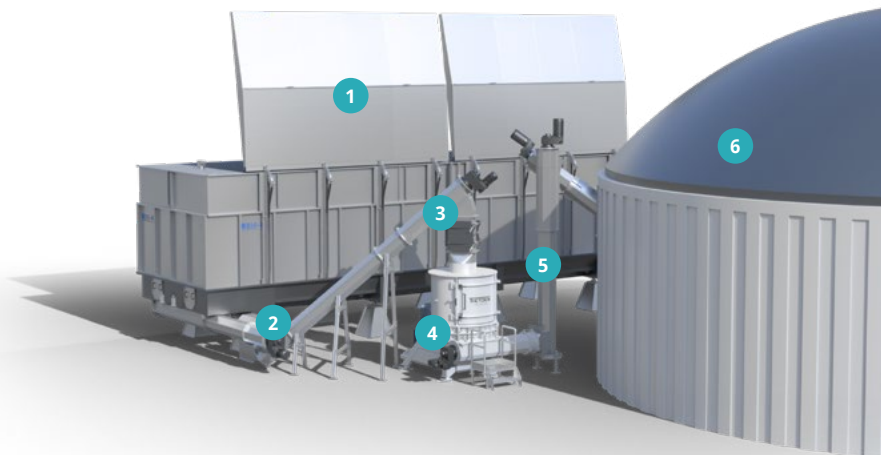

Good to Know Breaking of Fibers

Why breaking of fibers instead of cutting the biomass achieves a higher biogas yield?

When simply cutting stalks, the protective lignin layers on the outside remain largely intact. This layer is only interrupted at the cutting edges. As a result, the attack surfaces for microbacterial degradation are much smaller than with defibering, where the entire lignin

structure is largely destroyed. The specific surface area on which microorganisms can be broken down is significantly larger during defibration. This leads to a faster and more complete decomposition of the organic matter contained and thus to an increase in the biogas yield. At the same time, stirring energy is saved and the risk of floating layers is minimized.

How to Get the Digestion of Your Biogas Plant Going



IMPRA is installed in biogas plants downstream of the fermenter, where it processes the substrate components that are difficult to ferment even more finely.

The hammer mill IMPRA was developed to support fermenter biology. IMPRA works like a ruminant, grinding non-fermented substrates such as grass, corn silage, whole grain plants, solid manure, and straw, as well as miscanthus, millet and igniscum knotweed and other biomass rich plants. IMPRA uses the principle of impact grinding to make the lignin-protected content available for biological use. As the microorganisms in the fermenter have already broken down accessible organic matter, only what is necessary is grinded. In this way, the maximum economic value is extracted from the substrates. Impurities in the substrate are not a major problem for IMPRA, as the beaters can avoid them, are very robust and an integrated catch tray can separate out small impurities.



▲ Impurities are sorted out

✓ Advantages

- ▶ Increases the gas yield of existing biogas plants
- ▶ Up to 15 % higher gas yield
- ▶ Use of alternative raw materials
- ▶ No floating layers
- ▶ Higher organic load and shorter retention times

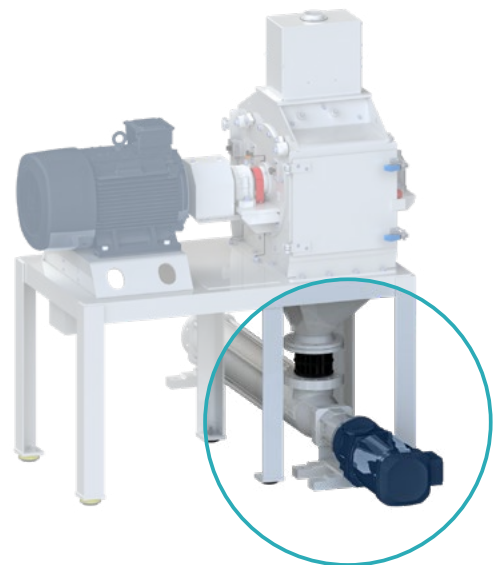

▲ Discharge pump transports processed substrate to an anaerobic digestion (AD) plant

Additional Income Through IMPRA

Thanks to the increased yield, IMPRA reduces the amount of raw materials consumed day by day.

Another advantage is the homogenization of the substrate in the fermenter. The viscosity is extremely reduced, making the contents much easier to stir. In addition, floating layers are reduced, and the natural bubbling of gas is facilitated. Together with the use of inexpensive raw materials and low operating costs, IMPRA pays for itself in a short period of time.

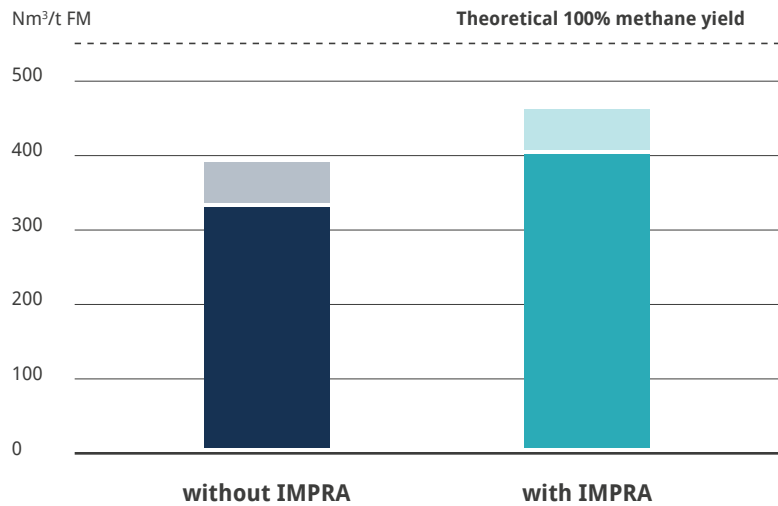

Substrate before and after processing with IMPRA. The improved viscosity is clearly visible.

Integration of the IMPRA Mill into the Biogas Plant

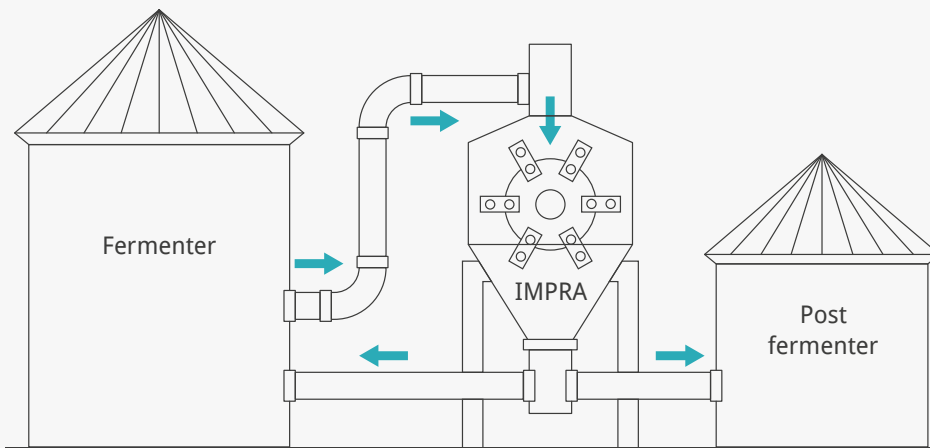



Plant Engineering

We can do more than just grinding, shredding and depackaging. As a solution provider, our focus is not just on the machine, but also on a clever system design that combines additional process steps. Together with our customers, we develop a customized plant design, from reception to conveying into the fermenter.

✓ Advantages

- ▶ Complete solution from a single source
- ▶ Minimization of interfaces
- ▶ Optimal integration of separating and grinding into the overall process
- ▶ Benefit from our process engineering know-how
- ▶ Integration of further process steps
- ▶ Consideration of framework conditions such as space conditions, regulations, occupational health and safety
- ▶ Comprehensive project support until start-up
- ▶ One contact person as project manager
- ▶ Mounting possible

Project Management & Coordination

We work with our customers on site to determine the available and required space and work out the optimal layout for the system. We help our customers with concepts and take into account the processes outside the system. We also gladly involve our clients' experienced staff.

Fabrication & Assembly

We manufacture machines and system components exactly according to planning specifications. Delivery and assembly are carried out punctually as agreed. When everything comes from a single source, many questions can be answered quickly.

Comissioning & Training

In addition to the actual functionality, we also ensure that aspects of operational safety are considered, that the legal requirements are met, and that appropriate instruction or training of the operating personnel enables professional maintenance and inspection. We are always willing to provide regular training to ensure that all employees are up to date.

Service and After Sales

A machine or system has to produce. It is therefore important that service quality and spare parts are available to minimize downtimes.

Whether you need brief information or advice, wish to order a few screws or a year's supply of replacement parts, or need an inspection or complete assembly – we are here to assist you.

As we know each of our installed machines down to the smallest detail, we can help you quickly and efficiently.

The experience of our long-standing employees and the flexibility of our team form the essential basis of our service quality.



With individual maintenance concepts, fast response times and our plant optimization, we increase the availability of your system.

Christophe-Maria Schulze
Head of Service and After Sales

Our Services

- ▶ Service worldwide
- ▶ Commissioning and system optimization
- ▶ Maintenance over the weekend
- ▶ Inspection, service and maintenance
- ▶ Spare parts stock
- ▶ Spare parts availability guaranteed for 20 years
- ▶ On-site and online training



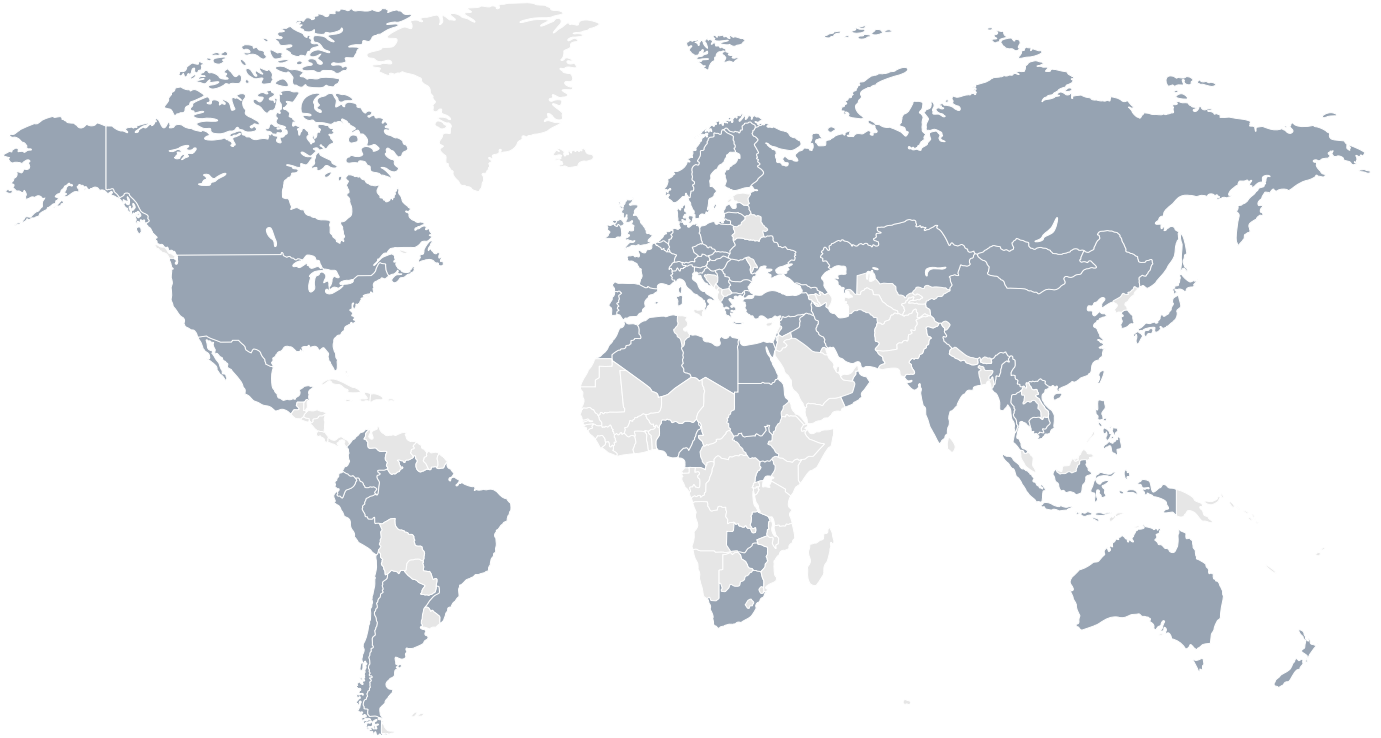

Investments Worldwide – Our references

More than 2,200 Tietjen machines have been installed worldwide since 1959. Our customers range from operators of small biogas plants with a few hundred kilowatts to large industrial plants in the megawatt range, large waste disposal companies and even power plants.

Standard Systems and Individual Plants for Waste Treatment

📍 Worldwide **DRM & PRS**



DRM and our plant engineering have established themselves internationally in addition to our core business in Germany.

Large and small waste treatment plants using our technology are currently being built in the Mediterranean region and in Asia.

Biomass in Scandinavia

📍 Scandinavia **BMS**



A maximised biogas yield in an economical way as well as an error-free system operation stands out as a primary concern for biogas plant owners. The biomass shredder BMS is integrated into various large biogas plants in Scandinavia, where it reliably processes challenging biomass like solid manure in just one step.

Individual Waste Treatment Plant

📍 Switzerland DRM



One of the largest wastewater treatment plants in Switzerland is the Ara region bern ag plant. In addition to wastewater treatment, our DRM is used to process biowaste. The renovation of the treatment plant in Bern is one of the largest biomass projects for Tietjen.

Production of Bioethanol, at the Red River Biorefinery

📍 USA Hammer mill



Ethanol is produced in North Dakota using Tietjen equipment. It is produced from 500,000 tons of sugar beet ends and potato residues per year. Tietjen is responsible for the defined grinding of the entire quantity and impresses with its reliable and robust machines.

Biogas Yield Increased

📍 Germany IMPRA



For Raimar Beckmann, Managing Director of Biogas Hermannshof GmbH in Germany, efficiency is most important: a 12 % higher methane yield thanks to IMPRA means considerable savings in raw materials for his 1.6 MW biogas plant and therefore greater flexibility and independence.

Find Our Brochures and Data Sheets Online

Technical data, more detailed images and unique selling points can be found in our data sheets.



🔗 tietjen-original.com/en/downloads

Tietjen Verfahrenstechnik GmbH

Vor der Horst 6
25485 Hemdingen
Germany

- Tel: +49 4106 63 33-0
- E-Mail: info@tietjen-original.com
- www.tietjen-original.com

Authorized to represent:
Thomas Runde



Tietjen worldwide

Here you find our sales partners:
www.tietjen-original.com/en/locations-and-sales-partners

Follow us: [in](#) [yt](#) [fb](#) [ig](#)